

BOSS®

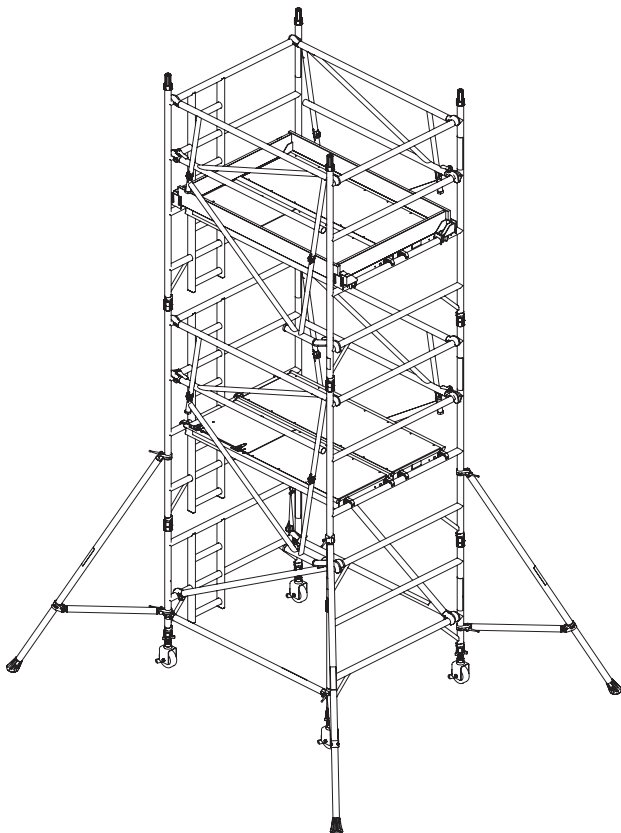

Ladderspan **AGR**

**BoSS Camlock Advance Guardrail
Mobile Aluminium Tower
1450/850 Frames**

Instruction Manual
EN 1004-2 en

Contents

1 Safety First

1.1	Introduction	2
1.2	Tower Designation	3
1.3	Maintenance - Storage - Transport	3

2 Building the Tower

2.1	Pre-Assembly Checks	4
2.2	Component Diagram	6
2.3	Quantity Schedule	8
2.4	Stabilisers	10
2.5	Assembly	11
	2.5.1 Assembly for 1450 & 850 Towers	13
2.6	Dismantling	20

3 Using the Tower

3.1	Safety Checklist	21
3.2	Pre-Use Checklist	21
3.3	Use	22
3.4	Movement of the Assembled Prefabricated Tower Scaffold	24

1 Safety First

1.1 Introduction

Please read this instruction manual carefully.

This instruction manual shall be available at the location of use of this mobile access tower. Instruction manuals are also available to download at www.bosssaccesstowers.com.



This product must be used in accordance with this manual without any modification.



FAILURE TO FOLLOW THESE INSTRUCTIONS MAY LEAD TO DEATH OR SERIOUS INJURY.

Mobile access towers must always be used in accordance with the national regulations. If any aspect of these instructions conflicts with local regulations, please contact Werner UK Sales & Distribution Limited for advice.

Please note that diagrams are for illustrative purposes only.

User training courses are available but must not be used as a substitute for familiarity with this manual.

BoSS mobile aluminium towers are light-weight scaffold towers used throughout the building and construction industry for both indoor and outdoor access solutions where a stable and secure platform is required. Ideal for maintenance and installation work or short-term access, the highly versatile towers provide a strong working platform for a variety of heights.

Verification and assessment documentation is held by Werner UK Sales & Distribution Limited.

Compliances



The BoSS Ladderspan AGR mobile tower system has been designed, tested, approved and certified to EN 1004-1:2020.

This instruction manual is in compliance with EN 1004-2-en.

1 Safety First

1.2 Tower Designation

EN 1004 3 8/12 XXXD H2

Design Code

Load Class (2 = 153kg/m² UDL, 3 = 204kg/m² UDL*)

Max. Platform Height Outdoors (m)

Max. Platform Height Indoors (m)

Access Method

A = Stairway, B = Stair Ladder, C = Inclined Ladder, D = Vertical Ladder

Clear Height Class (H1 = 1.85m, H2 = 1.90m)

*UDL = Uniformly distributed load

1.3 Maintenance - Storage - Transport

- The BoSS mobile tower system is robust and requires little maintenance.
- All components and their parts should be regularly inspected to identify damage, particularly to joints.
- Refer to the BoSS Inspection Guidance for detailed inspection and maintenance advice, the guidance is available to download at: www.bossacesstowers.com.
- Threads, hinges, and brace latches may be lubricated with light oil. Ensure oil does not contaminate climbing or walking surfaces.
- Safety labels should be kept legible. Replacement labels are available from Werner UK Sales & Distribution Limited.
- Surfaces should be kept reasonably free of dried paint, plaster etc.
- Use of solvents on wooden platform surfaces and plastic components should be avoided.
- Components should be stored in clean, dry conditions with due care to prevent damage.
- During transportation ensure components are not damaged by excessive strapping forces.

2 Building the Tower

2.1 Pre-Assembly Checks

- Check overhead that the area into which the structure is to be erected contains no obstructions, particularly electrical or radio radiation hazards. The structure is conductive.
- Ensure the ground on which the mobile access tower is to be erected is capable of supporting the tower in use.
- Check the surface is level within the 210mm range of the adjustable legs.
- Only components specified in this manual shall be used with BoSS towers. Check all required components are onsite and in a suitable working condition.
- Damaged components shall not be used and must be put beyond use and disposed of according to local regulations.



- Adjustable legs should only be used for levelling purposes and never to gain extra height.
- Ensure distance from the ground to first climbing rung is less than 400mm.
- Only climb the tower from the inside using the access method provided.

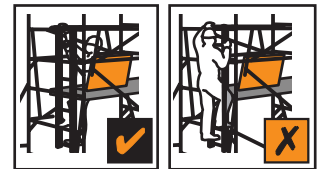

- This tower provides a work platform. It must not be used to access other structures.

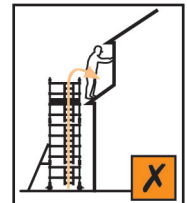

- Tower scaffolds are not designed to be lifted or suspended.
- Ensure the safe working load on the structure is not exceeded.
- Tools and materials should be lifted using a reliable lifting material (e.g. a strong rope) employing a reliable knot (e.g. clove hitch) to ensure safe fastening and always lift within the footprint of the prefabricated tower scaffold (i.e. within the area bounded by the stabilisers).

2 Building the Tower

- Check this manual is available and its contents familiar to all those involved.
- If assembling outdoors; check the forecast windspeed.
 - The assembled tower is certified to wind forces equating to 27mph, but handling components under those conditions would be hazardous.

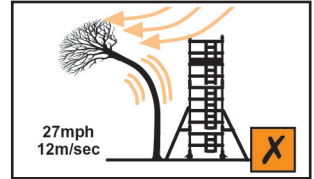

- Also consider the wind funnelling effect of nearby buildings.



- Towers greater than 8.2m platform height are for indoor use only.
- This structure is designed to be self-supporting under the loading condition requirements of EN 1004-1:2020 and does not require tying in. Consideration should be given to potential wind conditions if the tower is left unattended.

2 Building the Tower

2.2 Component Diagram

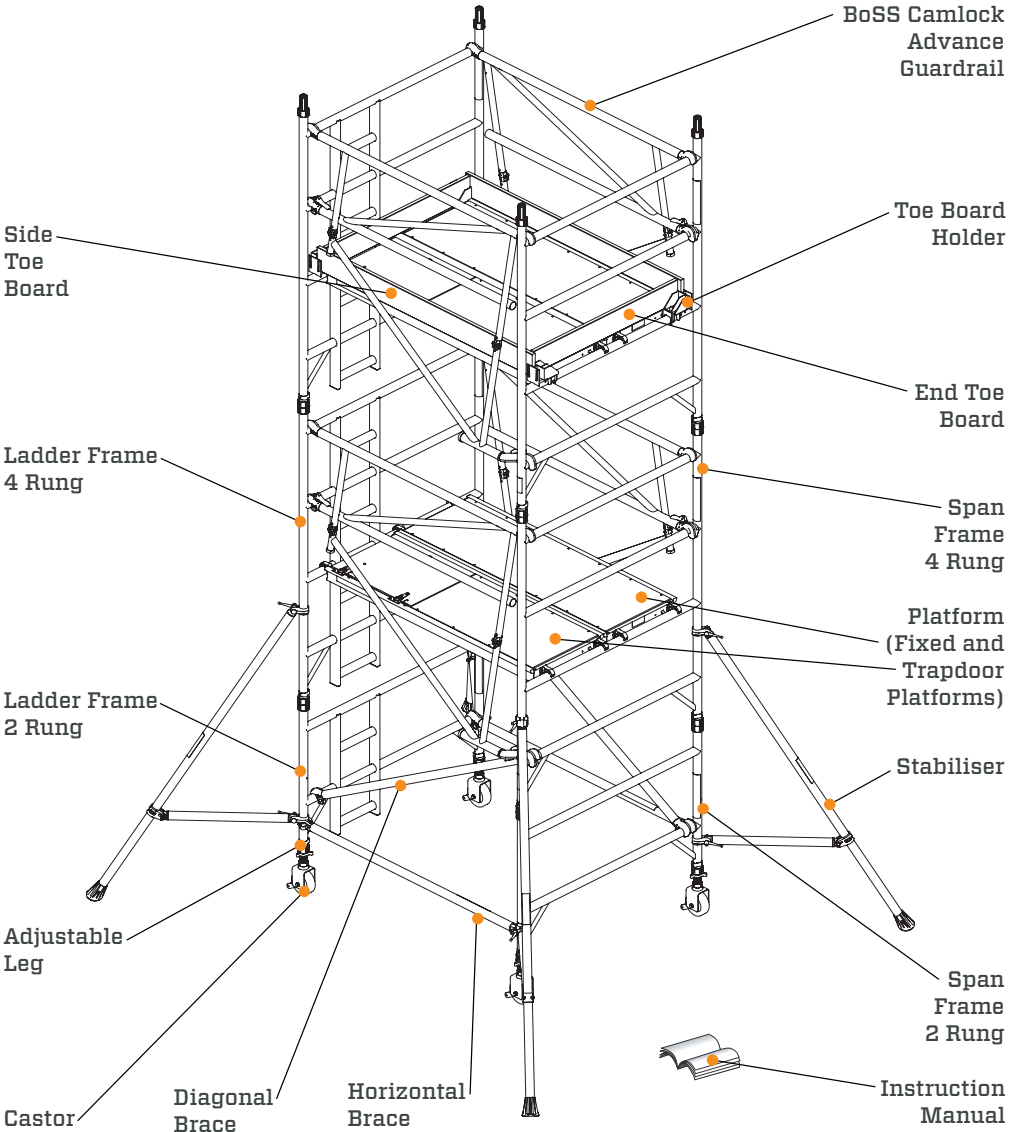

2 Building the Tower

Component Weights

Component		
Code	Name	Weight (kgs)
32842300	Castor 150mm	3.3
33551300	Adjustable Leg	1.1
60851300	Ladder Frame 850 2 Rung	4.7
60251300	Span Frame 850 2 Rung	2.7
60751300	Ladder Frame 850 3 Rung	6.7
60151300	Span Frame 850 3 Rung	3.4
60651300	Ladder Frame 850 4 Rung	8.7
60051300	Span Frame 850 4 Rung	4.1
61151300	Ladder Frame 1450 2 Rung	5.4
60551300	Span Frame 1450 2 Rung	4.0
61051300	Ladder Frame 1450 3 Rung	8.0
60451300	Span Frame 1450 3 Rung	5.6
60951300	Ladder Frame 1450 4 Rung	10.4
60351300	Span Frame 1450 4 Rung	7.1
36361500	Camlock Advance Guardrail 1.8m	8.4
36361600	Camlock Advance Guardrail 2.5m	10.0
30151100	Fixed Platform 1.8m	11.8
30251100	Fixed Platform 2.5m	16.0
30451100	Trapdoor Platform 1.8m	12.7
30551100	Trapdoor Platform 2.5m	16.3
31251300	Horizontal Brace 1.8m (red)	2.0
34851300	Horizontal Brace 2.5m (red)	2.4
31351300	Diagonal Brace 2.1m (blue)	2.1
31451300	Diagonal Brace 2.7m (blue)	2.5
30450900	Side Toe Board 1.8m	3.2
30550900	Side Toe Board 2.5m	4.4
30250900	End Toe Board 0.85m	1.0
30350900	End Toe Board 1.45m	2.1
30150900	Toe Board Holder	0.3
31751300	SP7 Fixed Stabiliser	3.8
31851300	SP10 Telescopic Stabiliser	8.8
31951300	SP15 Telescopic Stabiliser	12.8

2.3 Quantity Schedule

BOSS 1450 Ladderspan to EN 1004: Available in 2 lengths - 1.8m and 2.5m

Component	Working Height (m)	Internal or External Use											Internal Use															
		3.2	3.7	4.2	4.7	5.2	5.7	6.2	6.7	7.2	7.7	8.2	8.7	9.2	9.7	10.2	10.7	11.2	11.7	12.2	12.7	13.2	13.7	14.2				
Code	Name	1.2	1.7	2.2	2.7	3.2	3.7	4.2	4.7	5.2	5.7	6.2	6.7	7.2	7.7	8.2	8.7	9.2	9.7	10.2	10.7	11.2	11.7	12.2	12.7	13.2	13.7	14.2
33551300	Adjustable Leg	4	4	4	4	4	4	4	4	4	4	4	4	4	4	4	4	4	4	4	4	4	4	4	4	4	4	4
32842300	Castor 150mm	4	4	4	4	4	4	4	4	4	4	4	4	4	4	4	4	4	4	4	4	4	4	4	4	4	4	4
60551300	Span Frame 1450 2 Rung	-	1	1	-	-	1	1	-	1	1	-	-	1	1	-	-	1	1	-	-	1	1	-	-	1	1	-
60451300	Span Frame 1450 3 Rung	-	1	-	1	-	1	-	1	-	1	-	1	-	1	-	1	-	1	-	1	-	1	-	1	-	1	-
60351300	Span Frame 1450 4 Rung	1	-	1	1	2	1	2	2	3	2	3	4	3	4	3	4	4	5	4	5	4	5	6	5	6	5	6
61151300	Ladder Frame 1450 2 Rung	-	1	1	-	-	1	1	-	-	1	1	-	-	1	1	-	-	1	1	-	-	1	1	-	-	1	1
61051300	Ladder Frame 1450 3 Rung	-	1	-	1	-	1	-	1	-	1	-	1	-	1	-	1	-	1	-	1	-	1	-	1	-	1	-
60951300	Ladder Frame 1450 4 Rung	1	-	1	1	2	1	2	2	3	2	3	4	3	4	3	4	4	5	4	5	4	5	6	5	6	5	6
31251300 / 34851300	Horizontal Brace 1.8m and 2.5m (red)	2	2	2	2	2	2	2	2	2	2	2	2	2	2	2	2	2	2	2	2	2	2	2	2	2	2	2
31351300 / 31451300	Diagonal Brace 2.1m and 2.7m (blue)	-	2	2	4	-	2	2	4	-	2	2	4	-	2	2	4	-	2	2	4	-	2	2	4	-	2	2
36361500 / 36361600	Camlock AGR 1.8m and 2.5m	2	2	2	2	4	4	4	4	4	6	6	6	8	8	8	8	8	10	10	10	10	10	10	10	12	12	12
30451100 / 30551100	Trapdoor Platform 1.8m and 2.5m	1	1	1	1	2	2	2	2	3	3	3	3	4	4	4	4	4	5	5	5	5	5	5	5	6	6	6
30151100 / 30251100	Fixed Platform 1.8m and 2.5m	1	1	1	2*	2	2	2	2	3	3	3	3	4	4	4	4	4	5	5	5	5	5	5	5	6	6	6
31751300	SP7 Fixed Stabiliser	4	4	4	4	4	4	4	4	-	-	-	-	-	-	-	-	-	-	-	-	-	-	-	-	-	-	-
31851300	SP10 Telescopic Stabiliser	-	-	-	-	-	-	-	4	4	4	4	4	4	4	4	4	4	4	4	4	4	4	4	4	4	4	4
31951300	SP15 Telescopic Stabiliser	-	-	-	-	-	-	-	-	-	-	-	-	-	-	-	-	-	-	-	-	-	-	-	-	-	-	-
30150900	Toe Board Holder	4	4	4	4	4	4	4	4	4	4	4	4	4	4	4	4	4	4	4	4	4	4	4	4	4	4	4
30350900	End Toe Board 1.45m	2	2	2	2	2	2	2	2	2	2	2	2	2	2	2	2	2	2	2	2	2	2	2	2	2	2	2
30450900 / 30550900	Side Toe Board 1.8m and 2.5m	2	2	2	2	2	2	2	2	2	2	2	2	2	2	2	2	2	2	2	2	2	2	2	2	2	2	2
126637-01	Instruction Manual	1	1	1	1	1	1	1	1	1	1	1	1	1	1	1	1	1	1	1	1	1	1	1	1	1	1	1
Tower Total Self-weight 1.8m (kgs)		107	117	121	141	166	176	180	208	245	254	258	267	304	330	334	326	362	372	376	384	421	431	435	444	491	501	505
Tower Total Self-weight 2.5m (kgs)		121	132	136	161	191	202	206	235	281	292	296	305	351	379	383	375	421	431	435	444	491	501	505	554	564	566	567
Max. Exerted Leg Load 1.8m (kgs)		100	102	104	106	108	110	112	185	190	195	198	200	203	205	207	300	306	308	310	312	318	320	326	326	326	326	326
Max. Exerted Leg Load 2.5m (kgs)		228	230	233	235	238	240	243	375	379	380	383	385	388	390	393	550	554	555	557	560	564	566	567	567	567	567	567

*Apply first fixed platform to first rung during tower assembly procedure.

Building the Tower

BoSS 850 Ladderspan to EN 1004: Available in 2 lengths - 1.8m and 2.5m

Component		Internal or External Use														Internal Use											
Code	Name	Working Height (m)	Platform Height (m)	3.2	3.7	4.2	4.7	5.2	5.7	6.2	6.7	7.2	7.7	8.2	8.7	9.2	9.7	10.2	10.7	11.2	11.7	12.2	12.7	13.2	13.7	14.2	
				1.2	1.7	2.2	2.7	3.2	3.7	4.2	4.7	5.2	5.7	6.2	6.7	7.2	7.7	8.2	8.7	9.2	9.7	10.2	10.7	11.2	11.7	12.2	
33551300	Adjustable Leg			4	4	4	4	4	4	4	4	4	4	4	4	4	4	4	4	4	4	4	4	4	4	4	4
32842300	Castor 150mm			4	4	4	4	4	4	4	4	4	4	4	4	4	4	4	4	4	4	4	4	4	4	4	4
60251300	Span Frame 850 2 Rung			-	1	1	-	-	1	1	-	-	1	1	-	-	1	1	-	-	1	1	-	-	1	1	-
60151300	Span Frame 850 3 Rung			-	1	-	1	-	1	-	1	-	1	-	1	-	1	-	1	-	1	-	1	-	1	-	1
60051300	Span Frame 850 4 Rung			1	-	1	1	2	1	2	2	3	2	3	3	4	3	4	4	5	4	5	4	5	6	5	6
60851300	Ladder Frame 850 2 Rung			-	1	1	-	-	1	1	-	-	1	1	-	-	1	1	-	-	1	1	-	-	1	1	-
60751300	Ladder Frame 850 3 Rung			-	1	-	1	-	1	-	1	-	1	-	1	-	1	-	1	-	1	-	1	-	1	-	1
60651300	Ladder Frame 850 4 Rung			1	-	1	1	2	1	2	2	3	2	3	3	4	3	4	4	5	4	5	4	5	6	5	6
31251300 / 34851300	Horizontal Brace 1.8m and 2.5m (red)			2	2	2	2	2	2	2	2	2	2	2	2	2	2	2	2	2	2	2	2	2	2	2	2
31351300 / 31451300	Diagonal Brace 2.1m and 2.7m (blue)			-	2	2	4	-	2	2	4	-	2	2	4	-	2	2	4	-	2	4	-	2	4	-	2
36361500 / 36361600	Camlock AGR 1.8m and 2.5m			2	2	2	2	4	4	4	4	6	6	6	6	8	8	8	8	8	8	10	10	10	10	12	12
30451100 / 30551100	Trapdoor Platform 1.8m and 2.5m			1	1	1	1	2	2	2	2	3	3	3	3	4	4	4	4	4	4	5	5	5	5	6	6
30151100 / 30251100	Fixed Platform 1.8m and 2.5m			-	-	-	1	-	-	-	1	-	-	-	-	1	-	-	-	1	-	-	-	-	-	-	-
31751300	SP7 Fixed Stabiliser			4	4	4	4	4	4	-	-	-	-	-	-	-	-	-	-	-	-	-	-	-	-	-	-
31851300	SP10 Telescopic Stabiliser			-	-	-	-	-	-	4	4	4	4	4	4	4	4	4	4	4	4	4	4	4	4	4	4
31951300	SP15 Telescopic Stabiliser			-	-	-	-	-	-	-	-	-	-	-	-	-	-	-	-	-	-	-	-	-	-	-	4
30150900	Toe Board Holder			4	4	4	4	4	4	4	4	4	4	4	4	4	4	4	4	4	4	4	4	4	4	4	4
30250900	End Toe Board 0.85m			2	2	2	2	2	2	2	2	2	2	2	2	2	2	2	2	2	2	2	2	2	2	2	2
30450900 / 30550900	Side Toe Board 1.8m and 2.5m			2	2	2	2	2	2	2	2	2	2	2	2	2	2	2	2	2	2	2	2	2	2	2	2
126637-01	Instruction Manual			1	1	1	1	1	1	1	1	1	1	1	1	1	1	1	1	1	1	1	1	1	1	1	1
	Tower Total Self-weight 1.8m (kgs)			89	98	100	119	131	140	163	181	193	202	205	224	236	262	264	266	278	287	289	308	320	346	349	349
	Tower Total Self-weight 2.5m (kgs)			99	109	111	135	148	158	180	204	217	227	229	253	283	293	295	302	315	325	327	351	364	391	393	393
	Max. Exerted Leg Load 1.8m (kgs)			118	118	120	120	126	126	126	130	134	136	141	145	152	175	199	200	202	202	204	204	205	205	205	205
	Max. Exerted Leg Load 2.5m (kgs)			145	148	148	150	150	152	160	160	162	163	164	165	195	197	199	225	230	235	240	245	251	251	251	251

2 Building the Tower

Assembly Variations

This section lists the permitted component variation from the Quantity Schedule.

Note: These substitutions must be made before assembly.

Stabilisers

Stabilisers with Universal Clamps may be substituted:

Component Code	Description	Weight (kg)
31751400	SP7	4.0
31851400	SP10	9.0
31951400	SP15	13.1

Castors

Other Castor sizes and types may be substituted:

Component Code	Description	Weight (kg)
31842300	Diameter 150mm (Tyred)	3.2
32942300	Diameter 200mm	3.9
31942300	Diameter 200mm (Tyred)	3.9

2.4 Stabilisers

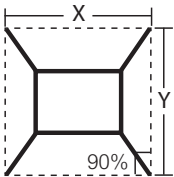

SP10 and SP15 stabilisers must always be fully extended.

Position the lower clamp so that the arm is as close to horizontal as possible. Adjust the position of the top clamp to ensure the stabiliser foot is in firm contact with the ground. Ensure the clamps are secure.

	Double Width 1450 Tower				Single Width 850 Tower			
	1.8m		2.5m		1.8m		2.5m	
	X (mm)	Y (mm)	X (mm)	Y (mm)	X (mm)	Y (mm)	X (mm)	Y (mm)
SP7	3242	3314	3544	3544	2930	2930	3110	3110
SP10	4832	4832	5100	5100	4072	4768	4032	5058
SP15	5510	5510	5218	6160	4700	5512	4226	6008

2 Building the Tower

2.5 Assembly

This tower structure must be assembled, and components oriented, in accordance with this instruction manual. Deviation from this instruction manual is not permitted.



THIS TOWER MUST NOT BE USED AS AN ANCHOR POINT FOR PERSONAL FALL PROTECTION EQUIPMENT.

- No tools are required for assembly.
- The assembly uses the AGR (Advanced Guardrail) method that provides collective fall protection.
 - Fit braces and AGR's in the locations described and ensure claws are locked.

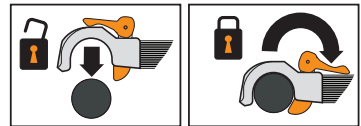
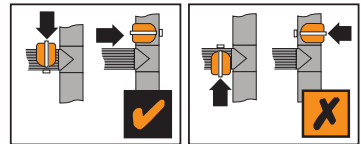

- DO NOT stand on an unprotected platform.



- The tower may be assembled by a single person, but it is recommended that two or more are used to pass up components on the taller assemblies.
- Components must be lifted within the footprint of the tower using a reliable method such as a strong rope with a clove hitch knot.
- Castor brakes should be locked as soon as the tower base is in position.
- The tower base should be levelled to within 0.6° before continuing the assembly.
- The adjustable legs are for levelling the tower only and not to be used to gain extra height.
- Ensure when the base is levelled the distance from the ground to the first climbing rung is less than 400mm.
- Stabilisers of the size specified in the quantity schedule should be fitted at the earliest opportunity.

2 Building the Tower

- Always start assembly with the smallest end frames at the base.

Platform Height (m)	1 st Frame	2 nd Frame	1 st Platform	1 st AGR
1.2, 3.2, 5.2, 7.2, 9.2, 11.2	4 Rung (2m)	4 Rung (2m)	2 nd Rung	1 st Rung
1.7, 3.7, 5.7, 9.7, 11.7	2 Rung (1m)	3 Rung (1.5m)	3 rd Rung	2 nd Rung
2.2, 4.2, 6.2, 8.2, 10.2, 12.2	2 Rung (1m)	4 Rung (2m)	4 th Rung	3 rd Rung
2.7, 4.7, 6.7, 8.7, 10.7	3 Rung (1.5m)	4 Rung (2m)	1 st Rung	4 th Rung

- Where all three frames are specified, start with the 2 Rung (1m), 3 Rung (1.5m) next and 4 Rung (2m) on top. Refer to the quantity schedule for details.

Platform Heights:

1.2m, 3.2m, 5.2m, 7.2m, 9.2m, 11.2m

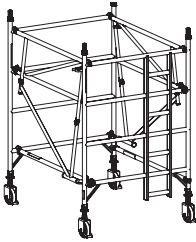

Platform Heights:

1.7m, 3.7m, 5.7m, 9.7m, 11.7m

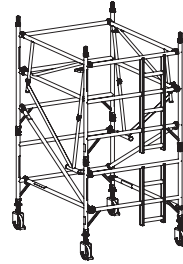

Platform Heights:

2.2m, 4.2m, 6.2m, 8.2m, 10.2m, 12.2m

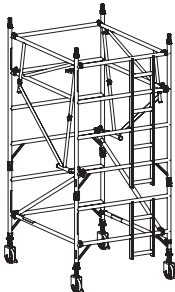

Platform Heights:

2.7m, 4.7m, 6.7m, 8.7m, 10.7m

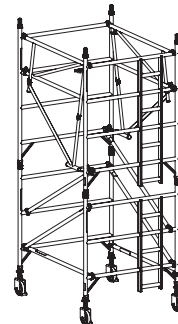

2 Building the Tower

2.5.1 Assembly for 1450 & 850 Towers

The procedure illustrated shows a 1450 tower 4.2m platform height starting with a 2 rung end frame.

1 Push castor into adjustable leg. Push castor/adjustable leg assemblies into a span frame. Lock castors. Repeat procedure with a ladder frame.

It is recommended that for ease of levelling a gap of 50mm is left between the bottom of the leg and the adjustable nut.

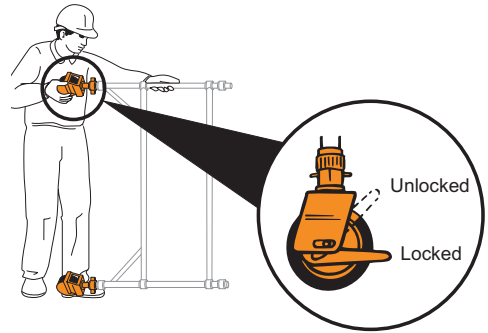

2 Fit one horizontal brace (red) onto the vertical of a span frame as shown, with the claw facing outwards. The frame will now be self-supporting.

All locking claws must be opened before fitting & positively locked after fitting.

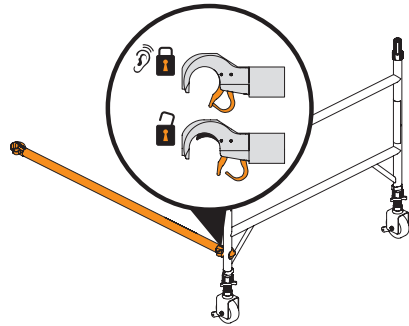

3 Position the ladder frame as shown and fit the other end of the horizontal brace on to the vertical.

Fit a second horizontal brace between the bottom rungs on the other side of the frames to square the tower.

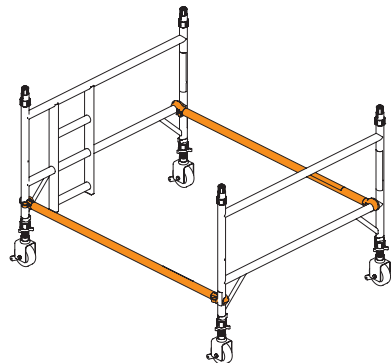

2 Building the Tower

4 Fit two additional end frames ensuring ladder sections line up and the frame interlock clips are engaged.

Fit two diagonal braces (blue) in opposite directions, from the 1st rung to the 3rd rung on the opposite side. Diagonal braces should be positioned 70/80mm inboard of the frame verticals.

Ensure the frames are vertical and level by checking with a spirit level and setting the adjustable legs as required.

Only use the adjustable legs to level tower and not to gain extra height.

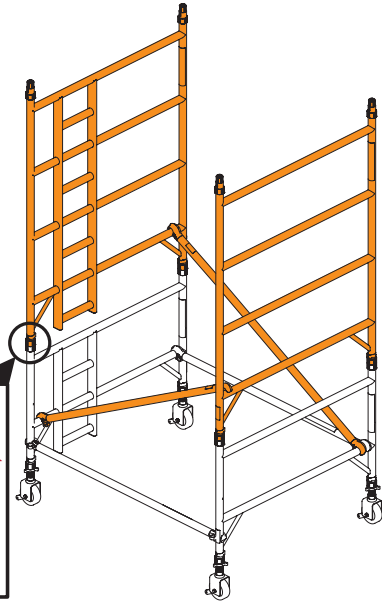
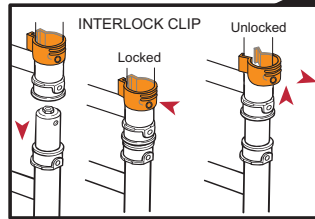

5 Fit two camlock AGR frames, one on each side of the tower. The lowest claw of the AGR must be fitted to the 3rd rung of the tower, as shown.

The uppermost and lowest AGR claws should be positioned 10/15mm inboard of the end frame verticals.

Secure each AGR frame by pulling the locking handle of the lowest claw firmly down.

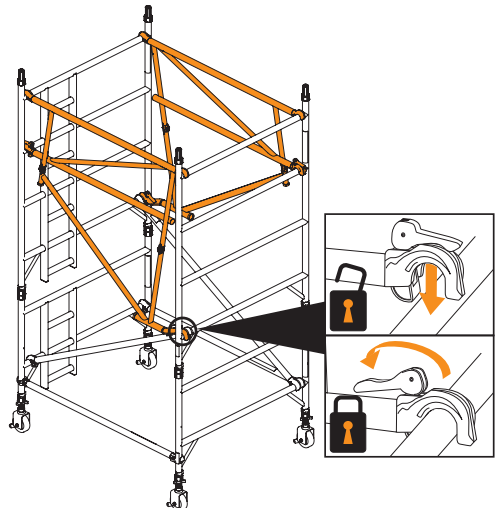

2 Building the Tower

Camlock Advance Guardrail (AGR) Frame Assembly Installation

5.1 Once AGR is secured in the unfolded position, place the AGR as shown, resting on the rung of the end frame.

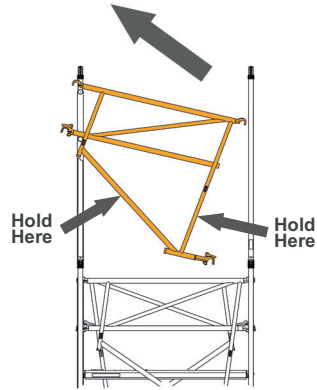

5.2 With AGR resting on the rung of the end frame, rotate AGR upwards into position shown.

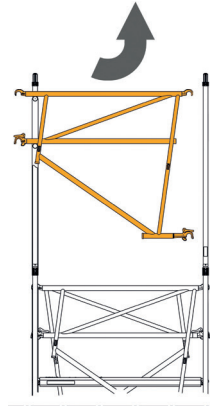

5.3 Lift AGR to ensure claw latch clears rung of end frame and move AGR across so both top hooks are above top rungs of end frames, as shown.

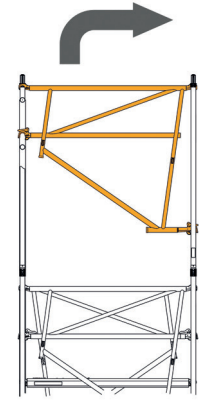

2 Building the Tower

5.4 Place AGR onto rungs of both end frames, ensuring both hooks and both claws are correctly positioned as shown. Engage locking handle of lowest claw.

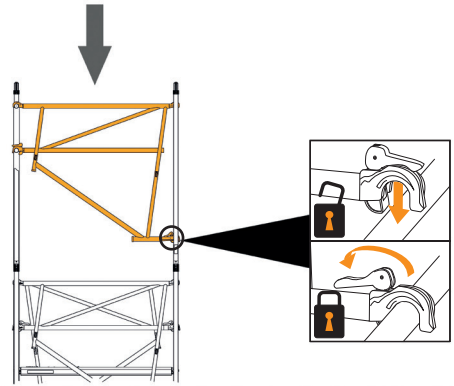

5.5 First AGR now in place with lower claw locked.

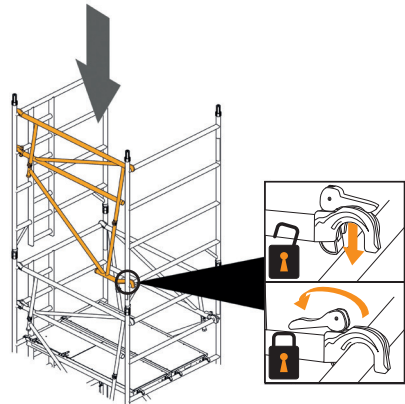

5.6 Repeat AGR installation steps for the second AGR on the opposite side of the tower, before fitting platforms.

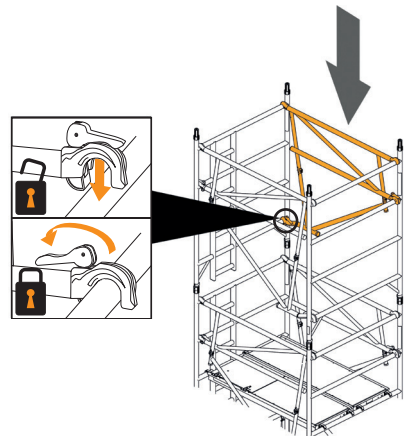

2 Building the Tower

6 Fit stabilisers (see notes on **page 10**).

For 1450 Towers: Fit a trapdoor platform and fixed platform on the 4th rung (2m), with the trapdoor next to the ladder. Ensure the trapdoor is positioned with the hinges towards the outside of the tower as shown.

For 850 Towers: Fit a trapdoor platform and fixed platform on the 4th rung (2m), with the trapdoor next to the ladder.

Ensure all platform wind-locks are engaged.

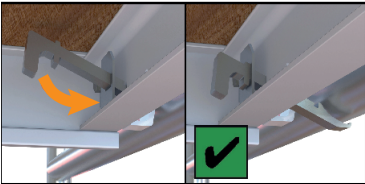

Climb onto platform above and lock each remaining camlock AGR claw.

Do not climb onto a platform unless all guardrails are in place.

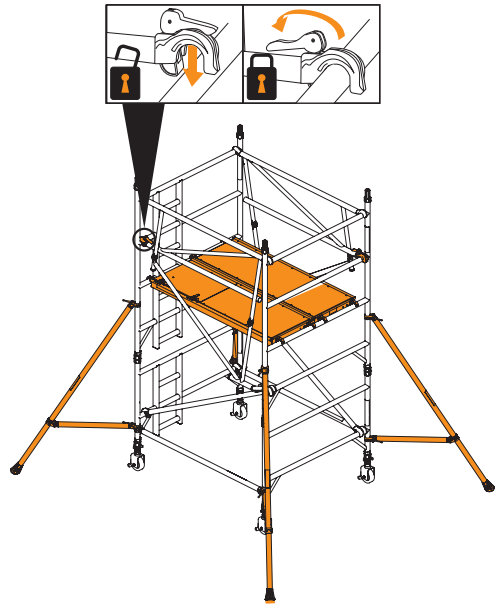

2 Building the Tower

7 Continue the procedure until the required height is reached, adding additional pairs of end frames, AGR frames and fitting trapdoor/fixed platforms, as shown on previous steps. For every platform level, add AGR frames from the platform below as guardrails (as shown in **Step 5**).

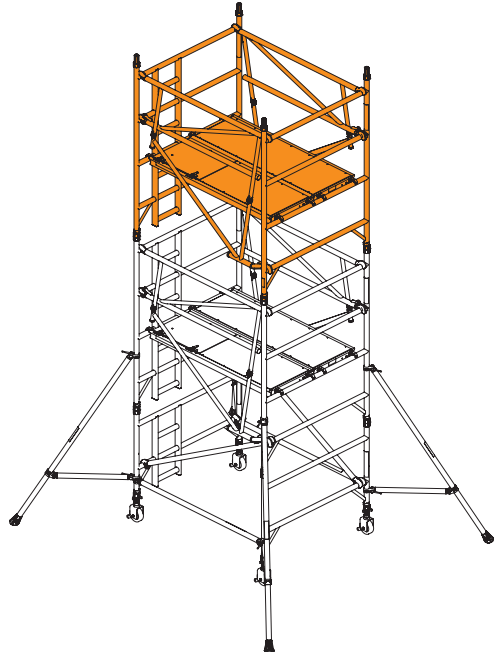

2 Building the Tower

8 Fit toe boards.

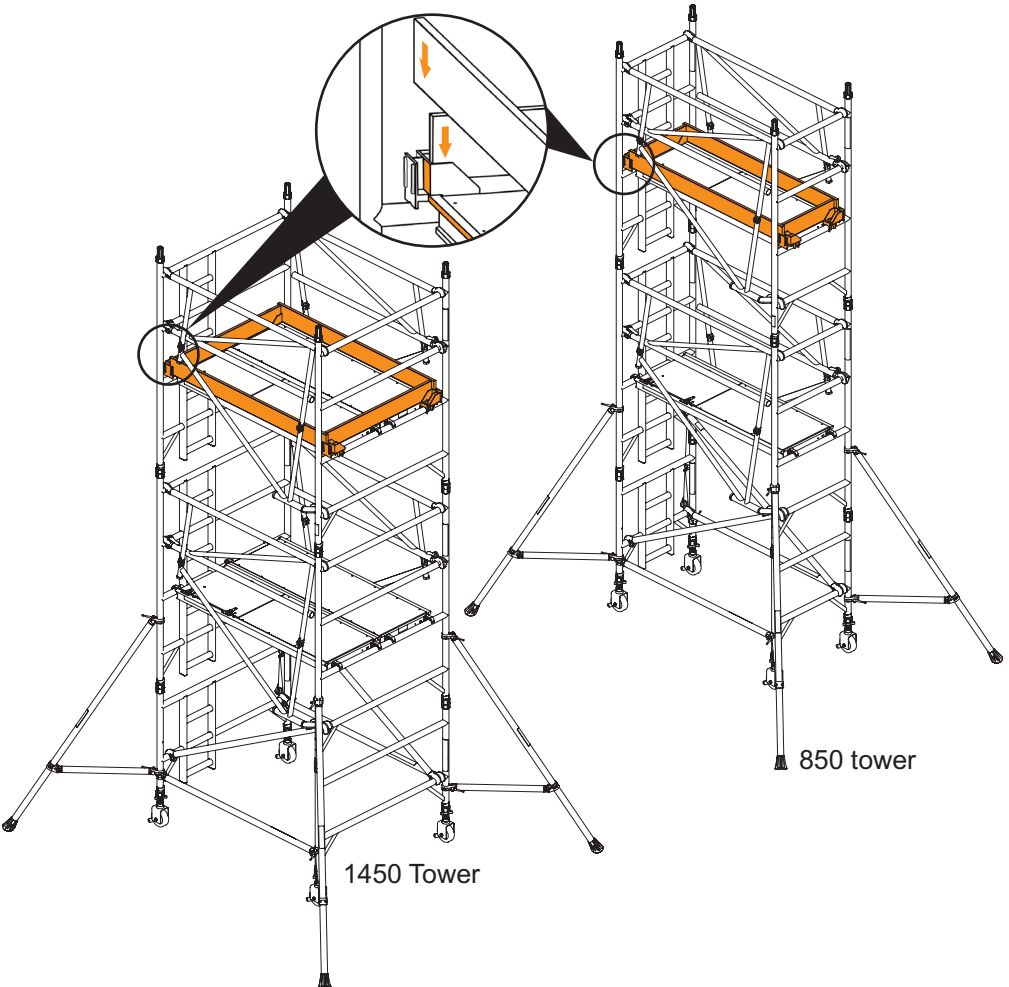

The tower is now complete.

2 Building the Tower

2.6 Dismantling

To dismantle the tower, reverse the assembly procedure.

When removing the AGR's, unlock the uppermost claw on each guardrail frame.

Descend the tower by one level.

Remove platforms.

Release one AGR lower claw and remove the guardrail.

Repeat for opposite AGR.

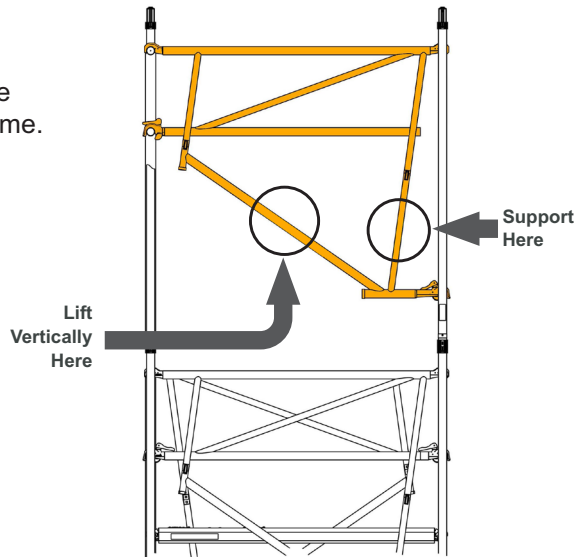











3 Using the Tower

3.1 Safety Checklist

This inspection must be carried out before initial use, after moving the tower, if any environmental condition change that may affect the tower and at regular intervals determined by local regulations.

Local regulations may also specify other information to be supplied to the user or attached to the structure. These regulations must be followed.

3.2 Pre-Use Checklist

Tower upright and level to within 0.6°	
Castor brakes locked and all wheels in ground contact	
All interlock clips engaged	
Braces/Guardrails correctly positioned	
All claws latched	
All platform wind-locks engaged	
Correct stabiliser size fitted and positioned	
Toe boards fitted to working platform	
Instruction manual available to user	
No environment changes affecting safe use have occurred or are likely	
Tower is the correct height for intended use	

3 Using the Tower

3.3 Use

- This tower must not be used as an anchor point for personal fall arrest equipment.
- The tower must only be climbed on the inside, using the access method specified.

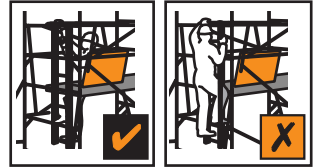

- This tower provides a work platform. It must not be used to access other structures.

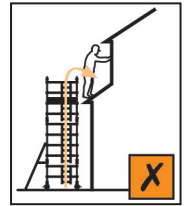

- Raising and lowering tools and materials must only be conducted within the tower footprint.
- Only one platform at a time can be used as a working platform. Toe boards must be fitted to that platform.
- Ensure the safe working load on the structure is not exceeded. The number of people permitted on the tower at any time is limited by the safe working load. The safe working loads for the entire platform area are shown below.

850 TOWERS CLASS 3:

1.8m x 0.85m: S.W.L = 208kg U.D.L

2.5m x 0.85m: S.W.L = 293kg U.D.L

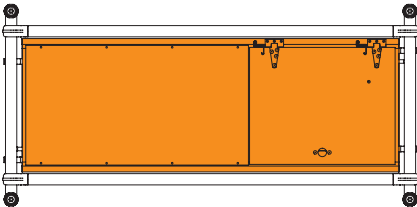

1450 TOWERS CLASS 3:

1.8m x 1.45m: S.W.L = 416kg U.D.L

2.5m x 1.45m: S.W.L = 586kg U.D.L

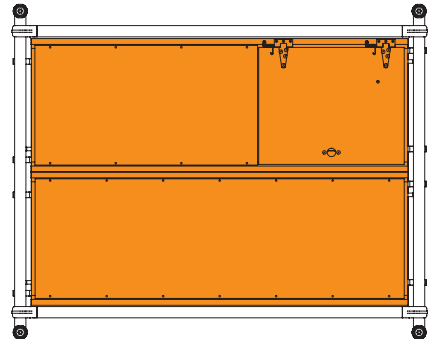

3 Using the Tower

- The adjustable legs are for levelling the tower only. They must not be used to gain extra height.
- Do not use boxes, stepladders or other objects to gain extra height.
- Beware of horizontal forces that might cause instability. Maximum horizontal force = 30kg.
- Beware of high winds. This tower has been assessed as a freestanding structure for wind loads equating to 27mph (43kph, 12m/s). If greater windspeeds are forecast the tower must be moved to a sheltered location or dismantled while it is still safe to do so.
- Sheets, tarpaulins, or signage must not be attached to this tower outdoors.
- Towers above 8.2m platform height are for indoor use only.

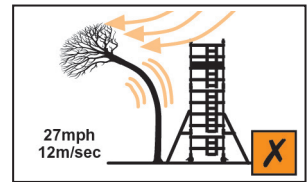
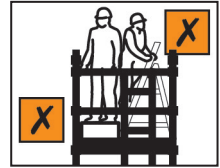

3 Using the Tower

3.4 Movement of the Assembled Prefabricated Tower Scaffold



MOVING A FULLY ASSEMBLED TOWER CAN BE EXTREMELY HAZARDOUS.

If there is any doubt about the safety of the move, the tower must be dismantled and reassembled in the new location.

This tower is not designed to be lifted or suspended.

Ensure gloves or other suitable hand protection is worn.

Before

- Beware of rough, sloping ground and high winds. Tower stability is improved by reducing height. Reduce the height of the tower prior to moving in accordance with any applicable and relevant risk assessment, safe system of work or method statement.
- Survey the route to be taken. Assess the ground condition/slope and any overhead obstructions or hazards and wind conditions.
- Ensure there are no persons, tools, or materials on the tower.
- Release the castor brakes.
- Release the stabiliser top clamp to allow the feet to be raised a maximum of 25mm. Re-tighten the clamps.

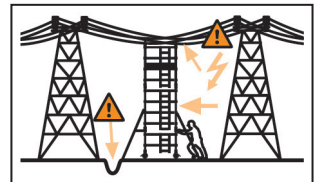

3 Using the Tower

During

- The tower must be moved only by manual effort, pushing at the base of the tower.
- The tower should never be moved faster than normal walking speed.
- Constant attention must be given to the position of the castors, stabiliser feet and the top of the tower.
- If there is any resistance to movement, stop and investigate the reason before continuing.

After

- As soon as the move is complete; lock the castor brakes, level the tower, lower the stabiliser feet, and perform the pre-use inspection.



For further information and support for the Ladderspan or any other products, design advice and services, please contact:

Werner UK Sales & Distribution Ltd.
Blackwater Trading Estate,
The Causeway, Maldon,
Essex, CM9 4LJ,
United Kingdom

WernerCo Hungary Kft.
6000 Kecskemét,
Szt. Istvan Krt. 19.

☎ +44 (0)1621 745900

✉ uk.customer@wernerco.com

🌐 bossacesstowers.com

Werner UK Sales & Distribution Ltd.
is a manufacturer member of:

