

# BOSS®

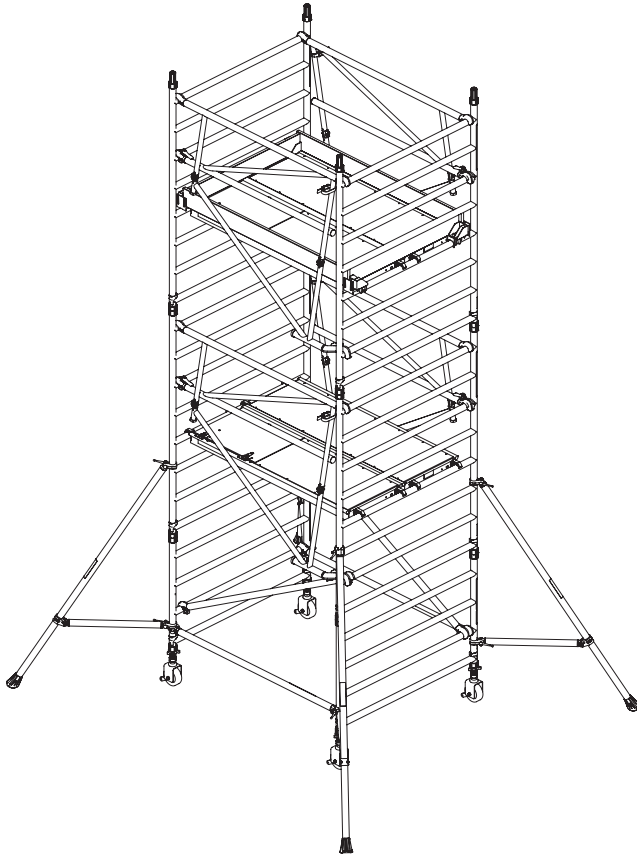

## Clima AGR

**BoSS Camlock Advance Guardrail  
Mobile Aluminium Tower  
1450/850 Frames**

**Instruction Manual**  
EN 1004-2 en



# Contents

## 1 Safety First

---

|     |                                   |   |
|-----|-----------------------------------|---|
| 1.1 | Introduction                      | 2 |
| 1.2 | Tower Designation                 | 3 |
| 1.3 | Maintenance - Storage - Transport | 3 |

## 2 Building the Tower

---

|     |                                      |    |
|-----|--------------------------------------|----|
| 2.1 | Pre-Assembly Checks                  | 4  |
| 2.2 | Component Diagram                    | 6  |
| 2.3 | Quantity Schedule                    | 8  |
| 2.4 | Stabilisers                          | 10 |
| 2.5 | Assembly                             | 11 |
|     | 2.5.1 Assembly for 1450 & 850 Towers | 13 |
| 2.6 | Dismantling                          | 19 |

## 3 Using the Tower

---

|     |  |    |
|-----|--|----|
| 3.1 | Safety Checklist                                       | 20 |
| 3.2 | Pre-Use Checklist                                      | 20 |
| 3.3 | Use  | 21 |
| 3.4 | Movement of the Assembled Prefabricated Tower Scaffold | 23 |

# 1 Safety First

## 1.1 Introduction

Please read this instruction manual carefully.

This instruction manual shall be available at the location of use of this mobile access tower. Instruction manuals are also available to download at [www.bossaccesstowers.com](http://www.bossaccesstowers.com).



This product must be used in accordance with this manual without any modification.



**FAILURE TO FOLLOW THESE INSTRUCTIONS MAY LEAD TO DEATH OR SERIOUS INJURY.**

Mobile access towers must always be used in accordance with the national regulations. If any aspect of these instructions conflicts with local regulations, please contact Werner UK Sales & Distribution Limited for advice.

Please note that diagrams are for illustrative purposes only.

User training courses are available but must not be used as a substitute for familiarity with this manual.

BoSS mobile aluminium towers are light-weight scaffold towers used throughout the building and construction industry for both indoor and outdoor access solutions where a stable and secure platform is required. Ideal for maintenance and installation work or short-term access, the highly versatile towers provide a strong working platform for a variety of heights.

Verification and assessment documentation is held by Werner UK Sales & Distribution Limited.

### Compliances



The BoSS Clima AGR mobile tower system has been designed, tested, approved and certified to EN 1004-1:2020.

This instruction manual is in compliance with EN 1004-2-en.

# 1 Safety First

## 1.2 Tower Designation

**EN 1004 3 8/12 XXXD H2**

Design Code

Load Class (2 = 153kg/m<sup>2</sup> UDL, 3 = 204kg/m<sup>2</sup> UDL\*)

Max. Platform Height Outdoors (m)

Max. Platform Height Indoors (m)

Access Method

A = Stairway, B = Stair Ladder, C = Inclined Ladder, D = Vertical Ladder

Clear Height Class (H1 = 1.85m, H2 = 1.90m)

\*UDL = Uniformly distributed load

## 1.3 Maintenance - Storage - Transport

- The BoSS mobile tower system is robust and requires little maintenance.
- All components and their parts should be regularly inspected to identify damage, particularly to joints.
- Refer to the BoSS Inspection Guidance for detailed inspection and maintenance advice, the guidance is available to download at: [www.bossacesstowers.com](http://www.bossacesstowers.com).
- Threads, hinges, and brace latches may be lubricated with light oil. Ensure oil does not contaminate climbing or walking surfaces.
- Safety labels should be kept legible. Replacement labels are available from Werner UK Sales & Distribution Limited.
- Surfaces should be kept reasonably free of dried paint, plaster etc.
- Use of solvents on wooden platform surfaces and plastic components should be avoided.
- Components should be stored in clean, dry conditions with due care to prevent damage.
- During transportation ensure components are not damaged by excessive strapping forces.

## 2 Building the Tower

### 2.1 Pre-Assembly Checks

- Check overhead that the area into which the structure is to be erected contains no obstructions, particularly electrical or radio radiation hazards. The structure is conductive.
- Ensure the ground on which the mobile access tower is to be erected is capable of supporting the tower in use.
- Check the surface is level within the 210mm range of the adjustable legs.
- Only components specified in this manual shall be used with BoSS towers. Check all required components are onsite and in a suitable working condition.
- Damaged components shall not be used and must be put beyond use and disposed of according to local regulations.



- Adjustable legs should only be used for levelling purposes and never to gain extra height.
- Ensure distance from the ground to first climbing rung is less than 400mm.
- Only climb the tower from the inside using the access method provided.

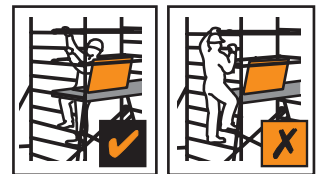

- This tower provides a work platform. It must not be used to access other structures.

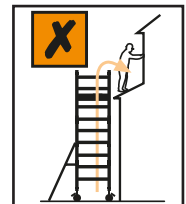

- Tower scaffolds are not designed to be lifted or suspended.
- Ensure the safe working load on the structure is not exceeded.
- Tools and materials should be lifted using a reliable lifting material (e.g. a strong rope) employing a reliable knot (e.g. clove hitch) to ensure safe fastening and always lift within the footprint of the prefabricated tower scaffold (i.e. within the area bounded by the stabilisers).

## 2 Building the Tower

- Check this manual is available and its contents familiar to all those involved.
- If assembling outdoors; check the forecast windspeed.
  - The assembled tower is certified to wind forces equating to 27mph, but handling components under those conditions would be hazardous.

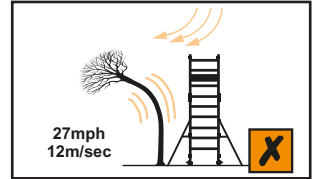

- Also consider the wind funnelling effect of nearby buildings.



- Towers greater than 8.2m platform height are for indoor use only.
- This structure is designed to be self-supporting under the loading condition requirements of EN 1004-1:2020 and does not require tying in. Consideration should be given to potential wind conditions if the tower is left unattended.

## 2 Building the Tower

### 2.2 Component Diagram

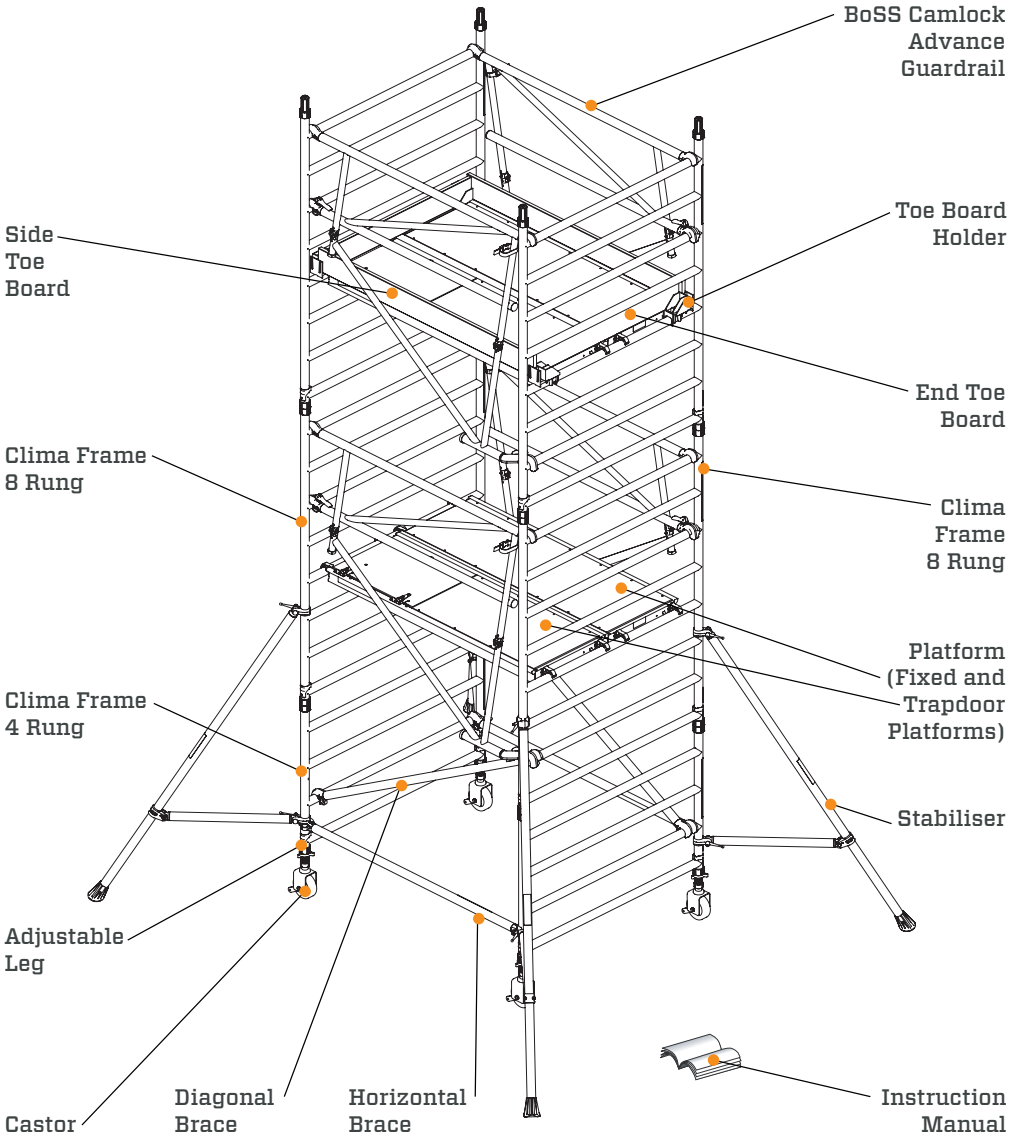



## 2 Building the Tower

### Component Weights

| Component |                                |              |
|-----------|--------------------------------|--------------|
| Code      | Name                           | Weight (kgs) |
| 32842300  | Castor 150mm                   | 3.3          |
| 33551300  | Adjustable Leg                 | 1.1          |
| 39251300  | Clima Frame 850 4 Rung         | 4.3          |
| 39451300  | Clima Frame 850 6 Rung         | 6.0          |
| 39351300  | Clima Frame 850 8 Rung         | 7.7          |
| 39151300  | Clima Frame 1450 4 Rung        | 5.9          |
| 39751300  | Clima Frame 1450 6 Rung        | 8.3          |
| 39651300  | Clima Frame 1450 8 Rung        | 10.8         |
| 36361500  | Camlock Advance Guardrail 1.8m | 8.4          |
| 36361600  | Camlock Advance Guardrail 2.5m | 10.0         |
| 30151100  | Fixed Platform 1.8m            | 11.8         |
| 30251100  | Fixed Platform 2.5m            | 16.0         |
| 30451100  | Trapdoor Platform 1.8m         | 12.7         |
| 30551100  | Trapdoor Platform 2.5m         | 16.3         |
| 31251300  | Horizontal Brace 1.8m (red)    | 2.0          |
| 34851300  | Horizontal Brace 2.5m (red)    | 2.4          |
| 31351300  | Diagonal Brace 2.1m (blue)     | 2.1          |
| 31451300  | Diagonal Brace 2.7m (blue)     | 2.5          |
| 30450900  | Side Toe Board 1.8m            | 3.2          |
| 30550900  | Side Toe Board 2.5m            | 4.4          |
| 30250900  | End Toe Board 0.85m            | 1.0          |
| 30350900  | End Toe Board 1.45m            | 2.1          |
| 30150900  | Toe Board Holder               | 0.3          |
| 31751300  | SP7 Fixed Stabiliser           | 3.8          |
| 31851300  | SP10 Telescopic Stabiliser     | 8.8          |
| 31951300  | SP15 Telescopic Stabiliser     | 12.8         |

## 2.3 Quantity Schedule

### BoSS 1450 Clima to EN 1004: Available in 2 lengths - 1.8m and 2.5m

| Component                          | Working Height (m)                   | Internal or External Use |     |     |     |     |     |     |     |     |     | Internal Use |     |     |     |      |      |      |      |      |      |      |      |      |      |      |      |      |
|------------------------------------|--------------------------------------|--------------------------|-----|-----|-----|-----|-----|-----|-----|-----|-----|--------------|-----|-----|-----|------|------|------|------|------|------|------|------|------|------|------|------|------|
|                                    |                                      | 3.2                      | 3.7 | 4.2 | 4.7 | 5.2 | 5.7 | 6.2 | 6.7 | 7.2 | 7.7 | 8.2          | 8.7 | 9.2 | 9.7 | 10.2 | 10.7 | 11.2 | 11.7 | 12.2 | 12.7 | 13.2 | 13.7 | 14.2 |      |      |      |      |
| Code                               | Name                                 | 1.2                      | 1.7 | 2.2 | 2.7 | 3.2 | 3.7 | 4.2 | 4.7 | 5.2 | 5.7 | 6.2          | 6.7 | 7.2 | 7.7 | 8.2  | 8.7  | 9.2  | 9.7  | 10.2 | 10.7 | 11.2 | 11.7 | 12.2 | 12.7 | 13.2 | 13.7 | 14.2 |
| 33551300                           | Adjustable Leg                       | 4                        | 4   | 4   | 4   | 4   | 4   | 4   | 4   | 4   | 4   | 4            | 4   | 4   | 4   | 4    | 4    | 4    | 4    | 4    | 4    | 4    | 4    | 4    | 4    | 4    | 4    | 4    |
| 32842300                           | Castor 150mm                         | 4                        | 4   | 4   | 4   | 4   | 4   | 4   | 4   | 4   | 4   | 4            | 4   | 4   | 4   | 4    | 4    | 4    | 4    | 4    | 4    | 4    | 4    | 4    | 4    | 4    | 4    | 4    |
| 39151300                           | Clima Frame 1450 4 Rung              | -                        | 2   | 2   | -   | -   | 2   | 2   | -   | -   | 2   | 2            | -   | -   | 2   | 2    | -    | -    | 2    | 2    | -    | -    | 2    | 2    | -    | -    | 2    | 2    |
| 39751300                           | Clima Frame 1450 6 Rung              | -                        | 2   | -   | 2   | -   | 2   | -   | 2   | -   | 2   | -            | 2   | -   | 2   | -    | 2    | -    | 2    | -    | 2    | -    | 2    | -    | 2    | -    | 2    | -    |
| 39651300                           | Clima Frame 1450 8 Rung              | 2                        | -   | 2   | 2   | 2   | 2   | 2   | 2   | 2   | 2   | 2            | 2   | 2   | 2   | 2    | 2    | 2    | 2    | 2    | 2    | 2    | 2    | 2    | 2    | 2    | 2    | 2    |
| 31251300 / 34851300                | Horizontal Brace 1.8m and 2.5m (red) | 2                        | 2   | 2   | 2   | 2   | 2   | 2   | 2   | 2   | 2   | 2            | 2   | 2   | 2   | 2    | 2    | 2    | 2    | 2    | 2    | 2    | 2    | 2    | 2    | 2    | 2    | 2    |
| 31351300 / 31451300                | Diagonal Brace 2.1m and 2.7m (blue)  | -                        | 2   | 2   | 2   | 2   | 2   | 2   | 2   | 2   | 2   | 2            | 2   | 2   | 2   | 2    | 2    | 2    | 2    | 2    | 2    | 2    | 2    | 2    | 2    | 2    | 2    | 2    |
| 36361500 / 36361600                | Camlock AGR 1.8m and 2.5m            | 2                        | 2   | 2   | 2   | 2   | 2   | 2   | 2   | 2   | 2   | 2            | 2   | 2   | 2   | 2    | 2    | 2    | 2    | 2    | 2    | 2    | 2    | 2    | 2    | 2    | 2    | 2    |
| 30451100 / 30551100                | Trapdoor Platform 1.8m and 2.5m      | 1                        | 1   | 1   | 1   | 2   | 2   | 2   | 2   | 2   | 2   | 2            | 2   | 3   | 3   | 3    | 3    | 3    | 4    | 4    | 4    | 4    | 4    | 5    | 5    | 5    | 6    | 6    |
| 30151100 / 30251100                | Fixed Platform 1.8m and 2.5m         | 1                        | 1   | 1   | 2*  | 2   | 2   | 2   | 2   | 2   | 2   | 2            | 2   | 3   | 3   | 3    | 3    | 3    | 4    | 4    | 4    | 4    | 4    | 5    | 5    | 5    | 6    | 6    |
| 31751300                           | SP7 Fixed Stabiliser                 | 4                        | 4   | 4   | 4   | 4   | 4   | 4   | 4   | 4   | 4   | 4            | -   | -   | -   | -    | -    | -    | -    | -    | -    | -    | -    | -    | -    | -    | -    | -    |
| 31851300                           | SP10 Telescopic Stabiliser           | -                        | -   | -   | -   | -   | -   | -   | 4   | 4   | 4   | 4            | 4   | 4   | 4   | 4    | 4    | 4    | 4    | 4    | 4    | 4    | 4    | 4    | 4    | 4    | 4    | 4    |
| 31951300                           | SP15 Telescopic Stabiliser           | -                        | -   | -   | -   | -   | -   | -   | -   | -   | -   | -            | -   | -   | -   | -    | -    | -    | 4    | 4    | 4    | 4    | 4    | 4    | 4    | 4    | 4    | 4    |
| 30150900                           | Toe Board Holder                     | 4                        | 4   | 4   | 4   | 4   | 4   | 4   | 4   | 4   | 4   | 4            | 4   | 4   | 4   | 4    | 4    | 4    | 4    | 4    | 4    | 4    | 4    | 4    | 4    | 4    | 4    | 4    |
| 30350900                           | End Toe Board 1.45m                  | 2                        | 2   | 2   | 2   | 2   | 2   | 2   | 2   | 2   | 2   | 2            | 2   | 2   | 2   | 2    | 2    | 2    | 2    | 2    | 2    | 2    | 2    | 2    | 2    | 2    | 2    | 2    |
| 30450900 / 30550900                | Side Toe Board 1.8m and 2.5m         | 2                        | 2   | 2   | 2   | 2   | 2   | 2   | 2   | 2   | 2   | 2            | 2   | 2   | 2   | 2    | 2    | 2    | 2    | 2    | 2    | 2    | 2    | 2    | 2    | 2    | 2    | 2    |
| 126638-01                          | Instruction Manual                   | 1                        | 1   | 1   | 1   | 1   | 1   | 1   | 1   | 1   | 1   | 1            | 1   | 1   | 1   | 1    | 1    | 1    | 1    | 1    | 1    | 1    | 1    | 1    | 1    | 1    | 1    | 1    |
| Tower Total Self-weight 1.8m (kgs) |                                      | 111                      | 122 | 127 | 148 | 174 | 185 | 190 | 219 | 257 | 268 | 273          | 282 | 320 | 348 | 354  | 345  | 383  | 394  | 399  | 408  | 446  | 457  | 462  | 462  | 462  | 462  | 462  |
| Tower Total Self-weight 2.5m (kgs) |                                      | 126                      | 137 | 143 | 168 | 200 | 211 | 217 | 246 | 294 | 305 | 311          | 320 | 368 | 379 | 385  | 394  | 442  | 453  | 459  | 468  | 516  | 527  | 533  | 533  | 533  | 533  | 533  |
| Max. Exerted Leg Load 1.8m (kgs)   |                                      | 69                       | 79  | 89  | 99  | 109 | 119 | 129 | 139 | 149 | 155 | 160          | 170 | 180 | 191 | 202  | 214  | 225  | 236  | 247  | 258  | 269  | 280  | 298  | 298  | 298  | 298  | 298  |
| Max. Exerted Leg Load 2.5m (kgs)   |                                      | 114                      | 123 | 133 | 144 | 154 | 163 | 173 | 192 | 212 | 232 | 252          | 260 | 268 | 274 | 285  | 291  | 297  | 303  | 310  | 316  | 322  | 328  | 339  | 339  | 339  | 339  | 339  |

\*Apply first fixed platform to first rung during tower assembly procedure.

## BoSS 850 Clima to EN 1004: Available in 2 lengths - 1.8m and 2.5m

| Component                          |                                      | Internal or External Use |     |     |     |     |     |     |     |     |     |     |     |     |     | Internal Use |      |      |      |      |      |      |      |      |      |
|------------------------------------|--------------------------------------|--------------------------|-----|-----|-----|-----|-----|-----|-----|-----|-----|-----|-----|-----|-----|--------------|------|------|------|------|------|------|------|------|------|
|                                    |                                      | Working Height (m)       | 3.2 | 3.7 | 4.2 | 4.7 | 5.2 | 5.7 | 6.2 | 6.7 | 7.2 | 7.7 | 8.2 | 8.7 | 9.2 | 9.7          | 10.2 | 10.7 | 11.2 | 11.7 | 12.2 | 12.7 | 13.2 | 13.7 | 14.2 |
| Code                               | Name                                 | Platform Height (m)      | 1.2 | 1.7 | 2.2 | 2.7 | 3.2 | 3.7 | 4.2 | 4.7 | 5.2 | 5.7 | 6.2 | 6.7 | 7.2 | 7.7          | 8.2  | 8.7  | 9.2  | 9.7  | 10.2 | 10.7 | 11.2 | 11.7 | 12.2 |
| 33551300                           | Adjustable Leg                       |                          | 4   | 4   | 4   | 4   | 4   | 4   | 4   | 4   | 4   | 4   | 4   | 4   | 4   | 4            | 4    | 4    | 4    | 4    | 4    | 4    | 4    | 4    | 4    |
| 32842300                           | Castor 150mm                         |                          | 4   | 4   | 4   | 4   | 4   | 4   | 4   | 4   | 4   | 4   | 4   | 4   | 4   | 4            | 4    | 4    | 4    | 4    | 4    | 4    | 4    | 4    | 4    |
| 39251300                           | Clima Frame 850 4 Rung               |                          | -   | 2   | 2   | -   | 2   | 2   | 2   | -   | 2   | 2   | -   | 2   | 2   | -            | 2    | 2    | -    | 2    | 2    | -    | 2    | 2    |      |
| 39451300                           | Clima Frame 850 6 Rung               |                          | -   | 2   | 2   | -   | 2   | 2   | 2   | -   | 2   | 2   | -   | 2   | 2   | -            | 2    | 2    | -    | 2    | 2    | -    | 2    | 2    |      |
| 39351300                           | Clima Frame 850 8 Rung               |                          | 2   | -   | 2   | 2   | 2   | 2   | 2   | 4   | 6   | 4   | 6   | 6   | 8   | 6            | 8    | 8    | 10   | 8    | 10   | 10   | 12   | 10   | 12   |
| 31251300 / 34851300                | Horizontal Brace 1.8m and 2.5m (red) |                          | 2   | 2   | 2   | 2   | 2   | 2   | 2   | 2   | 2   | 2   | 2   | 2   | 2   | 2            | 2    | 2    | 2    | 2    | 2    | 2    | 2    | 2    | 2    |
| 31351300 / 31451300                | Diagonal Brace 2.1m and 2.7m (blue)  |                          | -   | 2   | 2   | 4   | -   | 2   | 2   | 4   | -   | 2   | 2   | 4   | -   | 2            | 2    | 4    | -    | 2    | 2    | 4    | -    | 2    | 2    |
| 36361500 / 36361600                | Camlock AGR 1.8m and 2.5m            |                          | 2   | 2   | 2   | 2   | 2   | 4   | 4   | 4   | 6   | 6   | 6   | 6   | 8   | 8            | 8    | 8    | 10   | 10   | 10   | 10   | 12   | 12   | 12   |
| 30451100 / 30551100                | Trapdoor Platform 1.8m and 2.5m      |                          | 1   | 1   | 1   | 1   | 2   | 2   | 2   | 2   | 3   | 3   | 3   | 3   | 4   | 4            | 4    | 4    | 4    | 5    | 5    | 5    | 6    | 6    | 6    |
| 30151100 / 30251100                | Fixed Platform 1.8m and 2.5m         |                          | -   | -   | -   | 1   | -   | -   | -   | 1   | -   | -   | -   | 1   | -   | -            | -    | 1    | -    | -    | -    | 1    | -    | -    | -    |
| 31751300                           | SP7 Fixed Stabiliser                 |                          | 4   | 4   | 4   | 4   | 4   | 4   | 4   | 4   | -   | -   | 4   | -   | -   | -            | -    | -    | -    | -    | -    | -    | -    | -    | -    |
| 31851300                           | SP10 Telescopic Stabiliser           |                          | -   | -   | -   | -   | -   | -   | -   | -   | -   | -   | -   | -   | -   | -            | -    | -    | -    | -    | -    | -    | -    | -    | -    |
| 31951300                           | SP15 Telescopic Stabiliser           |                          | -   | -   | -   | -   | -   | -   | -   | -   | -   | -   | -   | -   | -   | -            | -    | -    | -    | -    | -    | -    | -    | -    | -    |
| 30150900                           | Toe Board Holder                     |                          | 4   | 4   | 4   | 4   | 4   | 4   | 4   | 4   | 4   | 4   | 4   | 4   | 4   | 4            | 4    | 4    | 4    | 4    | 4    | 4    | 4    | 4    | 4    |
| 30250900                           | End Toe Board 0.85m                  |                          | 2   | 2   | 2   | 2   | 2   | 2   | 2   | 2   | 2   | 2   | 2   | 2   | 2   | 2            | 2    | 2    | 2    | 2    | 2    | 2    | 2    | 2    | 2    |
| 30450900 / 30550900                | Side Toe Board 1.8m and 2.5m         |                          | 2   | 2   | 2   | 2   | 2   | 2   | 2   | 2   | 2   | 2   | 2   | 2   | 2   | 2            | 2    | 2    | 2    | 2    | 2    | 2    | 2    | 2    | 2    |
| 126638-01                          | Instruction Manual                   |                          | 1   | 1   | 1   | 1   | 1   | 1   | 1   | 1   | 1   | 1   | 1   | 1   | 1   | 1            | 1    | 1    | 1    | 1    | 1    | 1    | 1    | 1    | 1    |
| Tower Total Self-weight 1.8m (kgs) |                                      |                          | 91  | 101 | 104 | 124 | 136 | 146 | 149 | 189 | 201 | 211 | 214 | 233 | 246 | 273          | 276  | 278  | 291  | 300  | 304  | 323  | 336  | 345  | 349  |
| Tower Total Self-weight 2.5m (kgs) |                                      |                          | 101 | 112 | 115 | 140 | 153 | 163 | 187 | 211 | 225 | 235 | 239 | 263 | 277 | 304          | 308  | 315  | 329  | 339  | 342  | 367  | 380  | 390  | 394  |
| Max. Exerted Leg Load 1.8m (kgs)   |                                      |                          | 117 | 119 | 121 | 123 | 125 | 127 | 129 | 131 | 134 | 136 | 139 | 140 | 141 | 160          | 179  | 183  | 189  | 194  | 199  | 204  | 208  | 213  | 217  |
| Max. Exerted Leg Load 2.5m (kgs)   |                                      |                          | 118 | 126 | 134 | 142 | 146 | 148 | 156 | 165 | 174 | 180 | 187 | 196 | 205 | 212          | 220  | 230  | 240  | 249  | 258  | 268  | 278  | 289  | 297  |

## 2 Building the Tower

### Assembly Variations

This section lists the permitted component variation from the Quantity Schedule.

Note: These substitutions must be made before assembly.

#### Stabilisers

Stabilisers with Universal Clamps may be substituted:

| Component Code | Description | Weight (kg) |
|----------------|-------------|-------------|
| 31751400       | SP7         | 4.0         |
| 31851400       | SP10        | 9.0         |
| 31951400       | SP15        | 13.1        |

#### Castors

Other Castor sizes and types may be substituted:

| Component Code | Description            | Weight (kg) |
|----------------|------------------------|-------------|
| 31842300       | Diameter 150mm (Tyred) | 3.2         |
| 32942300       | Diameter 200mm         | 3.9         |
| 31942300       | Diameter 200mm (Tyred) | 3.9         |

### 2.4 Stabilisers

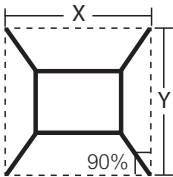

SP10 and SP15 stabilisers must always be fully extended.

Position the lower clamp so that the arm is as close to horizontal as possible. Adjust the position of the top clamp to ensure the stabiliser foot is in firm contact with the ground. Ensure the clamps are secure.

|      | Double Width 1450 Tower |        |        |        | Single Width 850 Tower |        |        |        |
|------|-------------------------|--------|--------|--------|------------------------|--------|--------|--------|
|      | 1.8m                    |        | 2.5m   |        | 1.8m                   |        | 2.5m   |        |
|      | X (mm)                  | Y (mm) | X (mm) | Y (mm) | X (mm)                 | Y (mm) | X (mm) | Y (mm) |
| SP7  | 3310                    | 3310   | 3544   | 3544   | 2930                   | 2930   | 3110   | 3110   |
| SP10 | 4832                    | 4832   | 5100   | 5100   | 4240                   | 4668   | 4032   | 5058   |
| SP15 | 5422                    | 5422   | 5218   | 6160   | 4700                   | 5464   | 4450   | 5926   |

## 2 Building the Tower

### 2.5 Assembly

This tower structure must be assembled, and components oriented, in accordance with this instruction manual. Deviation from this instruction manual is not permitted.



**THIS TOWER MUST NOT BE USED AS AN ANCHOR POINT FOR PERSONAL FALL PROTECTION EQUIPMENT.**

- No tools are required for assembly.
- The assembly uses the AGR (Advanced Guardrail) method that provides collective fall protection.
  - Fit braces and AGR's in the locations described and ensure claws are locked.

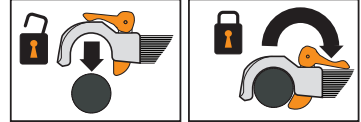
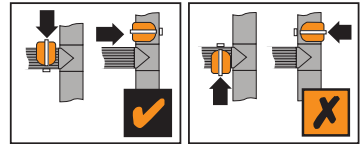

- DO NOT stand on an unprotected platform



- The tower may be assembled by a single person, but it is recommended that two or more are used to pass up components on the taller assemblies.
- Components must be lifted within the footprint of the tower using a reliable method such as a strong rope with a clove hitch knot.
- Castor brakes should be locked as soon as the tower base is in position.
- The tower base should be levelled to within 0.6° before continuing the assembly.
- The adjustable legs are for levelling the tower only and not to be used to gain extra height.
- Ensure when the base is levelled the distance from the ground to the first climbing rung is less than 400mm.
- Stabilisers of the size specified in the quantity schedule should be fitted at the earliest opportunity.

## 2 Building the Tower

- Always start assembly with the smallest end frames at the base.

| Platform Height (m)            | 1 <sup>st</sup> Frame | 2 <sup>nd</sup> Frame | 1 <sup>st</sup> Platform | 1 <sup>st</sup> AGR  |
|--------------------------------|-----------------------|-----------------------|--------------------------|----------------------|
| 1.2, 3.2, 5.2, 7.2, 9.2, 11.2  | 8 Rung (2m)           | 8 Rung (2m)           | 4 <sup>th</sup> Rung     | 2 <sup>nd</sup> Rung |
| 1.7, 3.7, 5.7, 9.7, 11.7       | 4 Rung (1m)           | 6 Rung (1.5m)         | 6 <sup>th</sup> Rung     | 4 <sup>th</sup> Rung |
| 2.2, 4.2, 6.2, 8.2, 10.2, 12.2 | 4 Rung (1m)           | 8 Rung (2m)           | 8 <sup>th</sup> Rung     | 6 <sup>th</sup> Rung |
| 2.7, 4.7, 6.7, 8.7, 10.7       | 6 Rung (1.5m)         | 8 Rung (2m)           | 2 <sup>nd</sup> Rung     | 8 <sup>th</sup> Rung |

- Where all three frames are specified, start with the 4 Rung (1m), 6 Rung (1.5m) next and 8 Rung (2m) on top. Refer to the quantity schedule for details.

Platform Heights:

1.2m, 3.2m, 5.2m, 7.2m, 9.2m, 11.2m

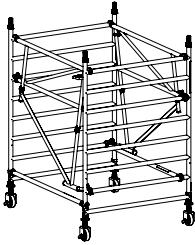

Platform Heights:

1.7m, 3.7m, 5.7m, 9.7m, 11.7m

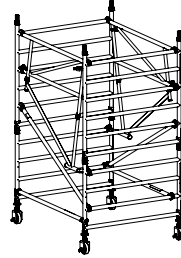

Platform Heights:

2.2m, 4.2m, 6.2m, 8.2m, 10.2m, 12.2m

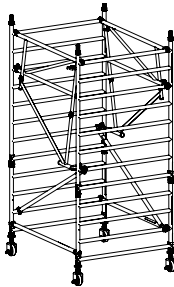

Platform Heights:

2.7m, 4.7m, 6.7m, 8.7m, 10.7m

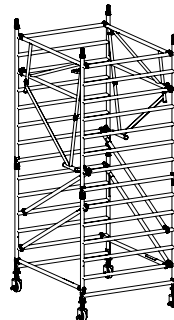

## 2 Building the Tower

### 2.5.1 Assembly for 1450 & 850 Towers

The procedure illustrated shows a 1450 tower 4.2m platform height starting with a 4 rung end frame.

**1** Push castor into adjustable leg. Push castor/adjustable leg assemblies into a clima frame. Lock castors. Repeat procedure with second clima frame.

It is recommended that for ease of levelling a gap of 50mm is left between the bottom of the leg and the adjustable nut.

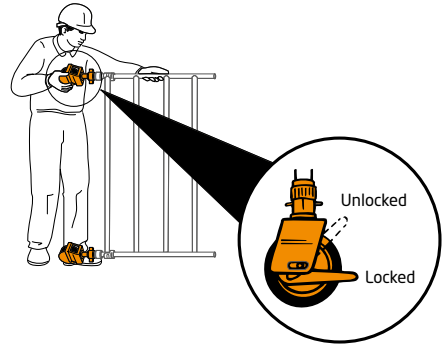

**2** Fit one horizontal brace (red) onto the vertical of a clima frame as shown, with the claw facing outwards. The frame will now be self-supporting.

**All locking claws must be opened before fitting & positively locked after fitting.**

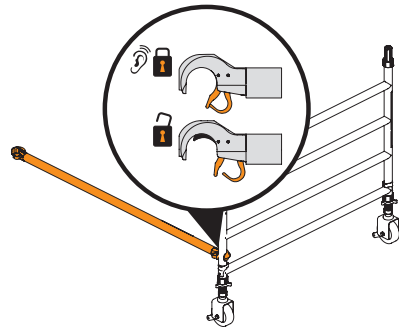

**3** Position the second clima frame as shown and fit the other end of the horizontal brace on to the vertical.

Fit a second horizontal brace between the 2<sup>nd</sup> rungs on the other side of the frames to square the tower.

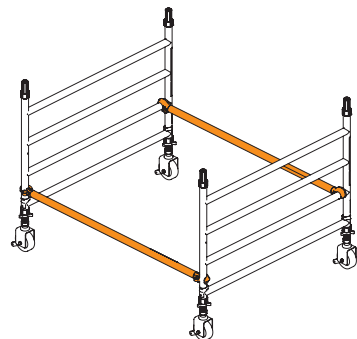

## 2 Building the Tower

- 4** Fit two additional end frames and ensure the frame interlock clips are engaged.

Fit two diagonal braces (blue) in opposite directions, from the 2<sup>nd</sup> rung to the 6<sup>th</sup> rung on the opposite side. Diagonal braces should be positioned 70/80mm inboard of the frame verticals.

Ensure the frames are vertical and level by checking with a spirit level and setting the adjustable legs as required.

**Only use the adjustable legs to level the tower and not to gain extra height.**

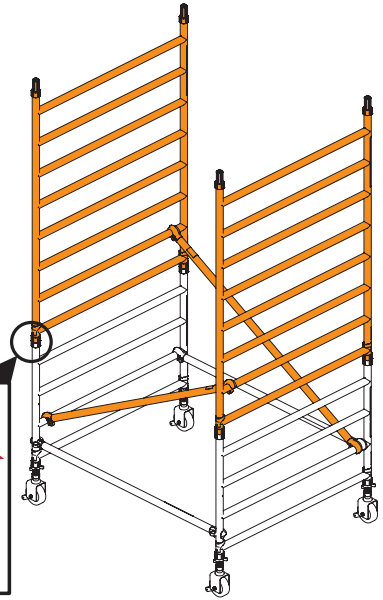
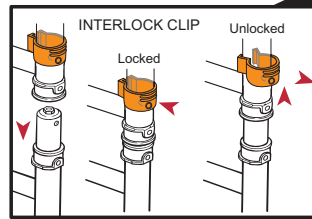

- 5** Fit two camlock AGR frames, one on each side of the tower. The lowest claw of the AGR must be fitted to the 6<sup>th</sup> rung of the tower, as shown.

The uppermost and lowest AGR claws should be positioned 10/15mm inboard of the end frame verticals.

Secure each AGR frame by pulling the locking handle of the lowest claw firmly down.

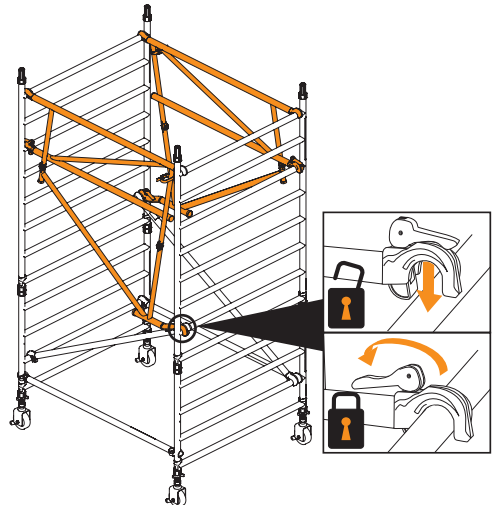



## 2 Building the Tower

### Camlock Advance Guardrail (AGR) Frame Assembly Installation

**5.1** Once AGR is secured in the unfolded position, place the AGR as shown, resting on the rung of the end frame.

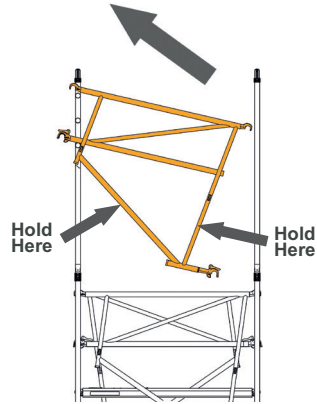

**5.2** With AGR resting on the rung of the end frame, rotate AGR upwards into position shown.

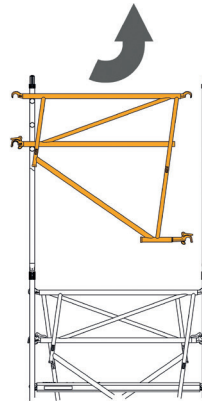

**5.3** Lift AGR to ensure claw latch clears rung of end frame and move AGR across so both top hooks are above top rungs of end frames, as shown.

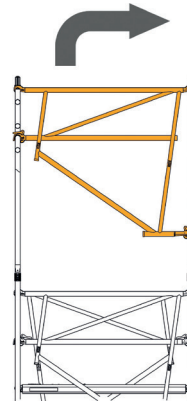

## 2 Building the Tower

**5.4** Place AGR onto rungs of both end frames, ensuring both hooks and both claws are correctly positioned as shown. Engage locking handle of lowest claw.

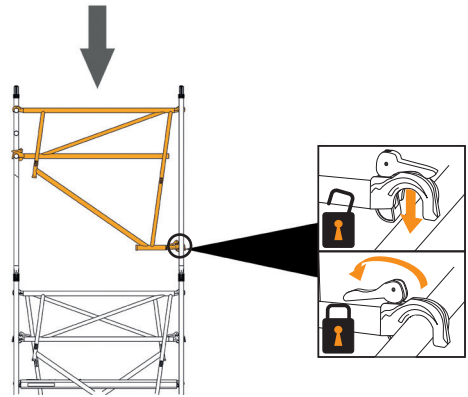

**5.5** First AGR now in place with lower claw locked.

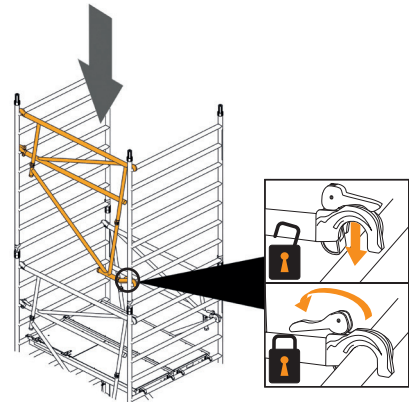

**5.6** Repeat AGR installation steps for the second AGR on the opposite side of the tower, before fitting platforms.

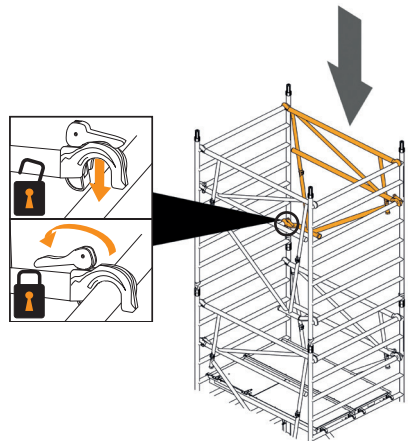

## 2 Building the Tower

**6** Fit stabilisers (see notes on **page 10**).

**For 1450 Towers:** Fit a trapdoor platform and fixed platform on the 4<sup>th</sup> rung (2m). Ensure the trapdoor is positioned with the hinges towards the outside of the tower as shown.

**For 850 Towers:** Fit a trapdoor platform on the 4<sup>th</sup> rung (2m).

Ensure all platform wind-locks are engaged.

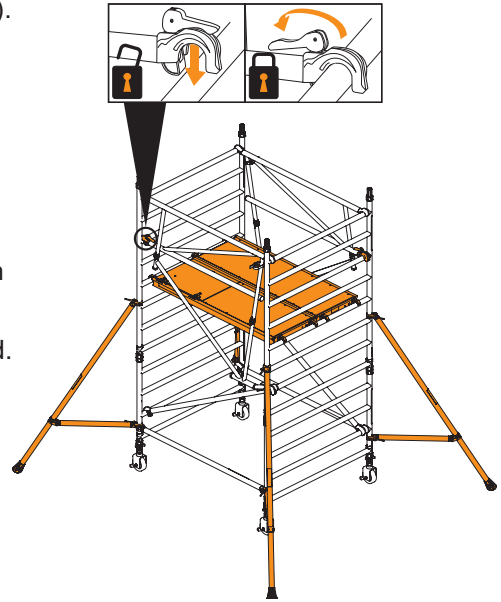
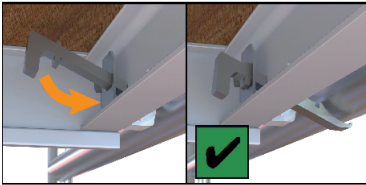

Climb onto platform above and lock each remaining camlock AGR claw.

**Do not climb onto a platform unless all guardrails are in place.**

**7** Continue the procedure until the required height is reached, adding additional pairs of end frames, AGR frames and fitting trapdoor/fixed platforms, as shown on previous steps. For every platform level, add AGR frames from the platform below as guardrails (as shown in **Step 5**).

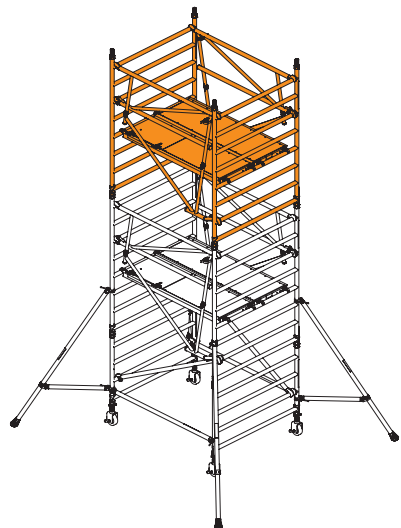

## 2 Building the Tower

8 Fit toe boards.

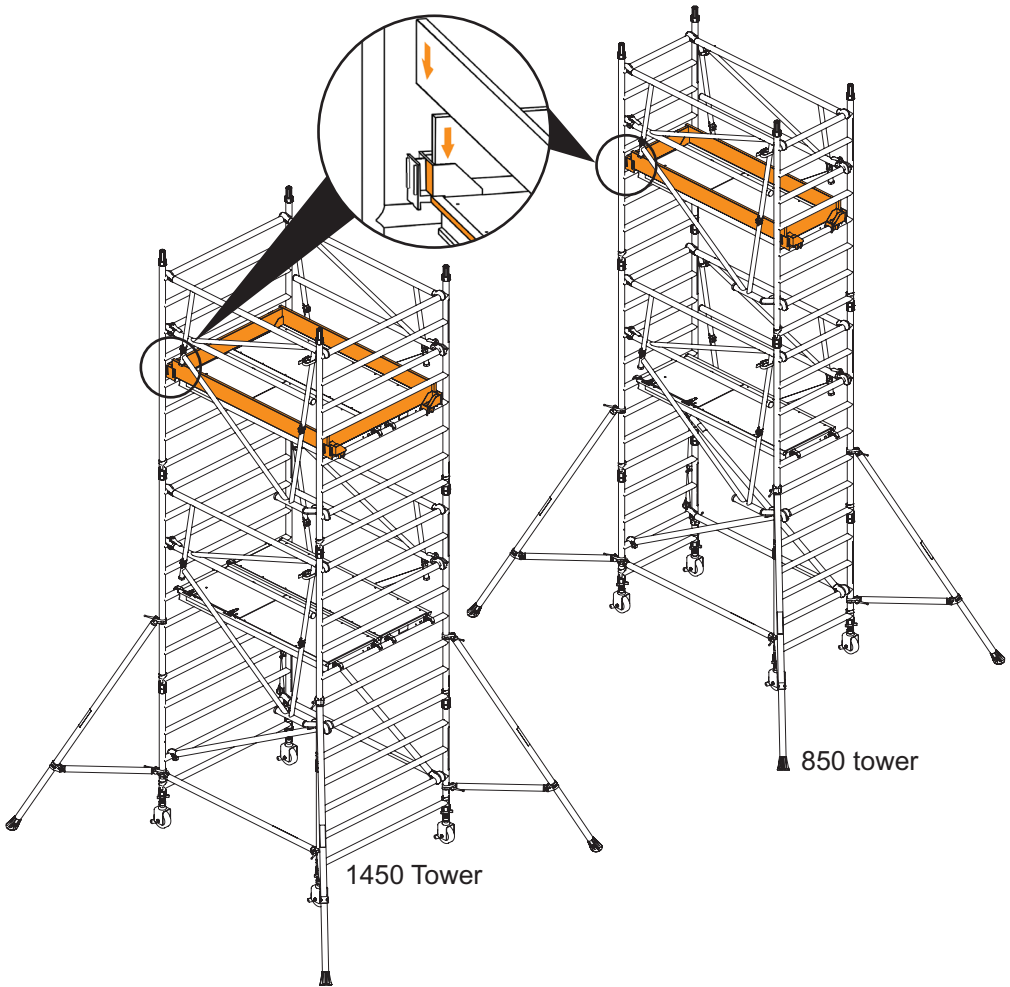

The tower is now complete.

## 2 Building the Tower

### 2.6 Dismantling

To dismantle the tower, reverse the assembly procedure.

When removing the AGR's, unlock the uppermost claw on each guardrail frame.

Descend the tower by one level.

Remove platforms.

Release one AGR lower claw and remove the guardrail.

Repeat for opposite AGR.

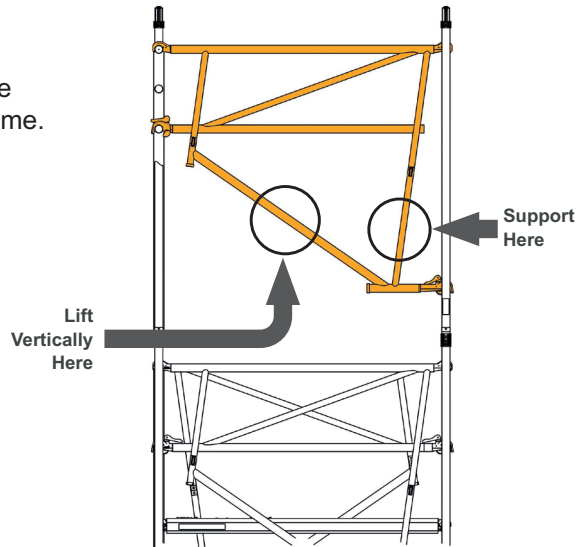

## 3 Using the Tower

### 3.1 Safety Checklist











---

This inspection must be carried out before initial use, after moving the tower, if any environmental condition change that may affect the tower and at regular intervals determined by local regulations.

Local regulations may also specify other information to be supplied to the user or attached to the structure. These regulations must be followed.

### 3.2 Pre-Use Checklist

---

|   |   |
|---|---|
| Tower upright and level to within 0.6°                                |    |
| Castor brakes locked and all wheels in ground contact                 |    |
| All interlock clips engaged   |    |
| Braces/Guardrails correctly positioned                                |    |
| All claws latched   |    |
| All platform wind-locks engaged                                       |    |
| Correct stabiliser size fitted and positioned                         |    |
| Toe boards fitted to working platform                                 |  |
| Instruction manual available to user                                  |  |
| No environment changes affecting safe use have occurred or are likely |  |
| Tower is the correct height for intended use                          |  |

## 3 Using the Tower

### 3.3 Use

- This tower must not be used as an anchor point for personal fall arrest equipment.
- The tower must only be climbed on the inside, using the access method specified.

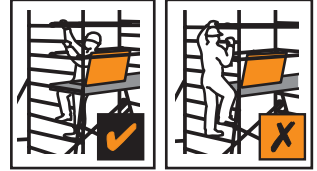

- This tower provides a work platform. It must not be used to access other structures.

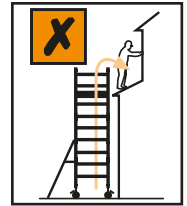

- Raising and lowering tools and materials must only be conducted within the tower footprint.
- Only one platform at a time can be used as a working platform. Toe boards must be fitted to that platform.
- Ensure the safe working load on the structure is not exceeded. The number of people permitted on the tower at any time is limited by the safe working load. The safe working loads for the entire platform area are shown below.

#### 850 TOWERS CLASS 3:

1.8m x 0.85m: S.W.L = 208kg U.D.L

2.5m x 0.85m: S.W.L = 293kg U.D.L

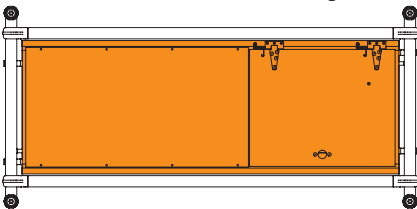

#### 1450 TOWERS CLASS 3:

1.8m x 1.45m: S.W.L = 416kg U.D.L

2.5m x 1.45m: S.W.L = 586kg U.D.L

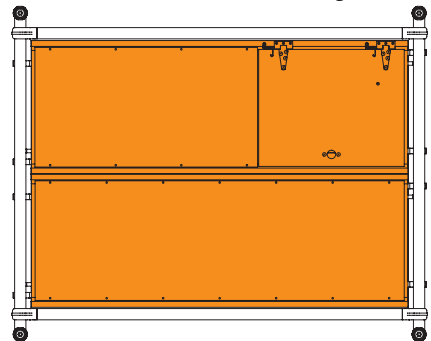

### 3 Using the Tower

- The adjustable legs are for levelling the tower only. They must not be used to gain extra height.
- Do not use boxes, stepladders or other objects to gain extra height.

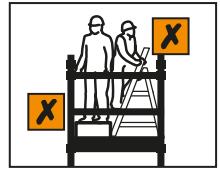

- Beware of horizontal forces that might cause instability. Maximum horizontal force = 30kg.



- Beware of high winds. This tower has been assessed as a freestanding structure for wind loads equating to 27mph (43kph, 12m/s). If greater windspeeds are forecast the tower must be moved to a sheltered location or dismantled while it is still safe to do so.

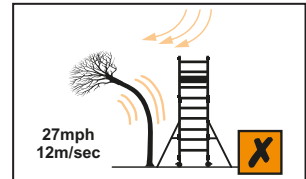

- Sheets, tarpaulins, or signage must not be attached to this tower outdoors.
- Towers above 8.2m platform height are for indoor use only.



## 3 Using the Tower

### 3.4 Movement of the Assembled Prefabricated Tower Scaffold



**MOVING A FULLY ASSEMBLED TOWER CAN BE EXTREMELY HAZARDOUS.**

If there is any doubt about the safety of the move, the tower must be dismantled and reassembled in the new location.

This tower is not designed to be lifted or suspended.

Ensure gloves or other suitable hand protection is worn.

#### Before

- Beware of rough, sloping ground and high winds. Tower stability is improved by reducing height. Reduce the height of the tower prior to moving in accordance with any applicable and relevant risk assessment, safe system of work or method statement.

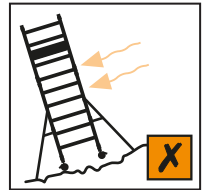

- Survey the route to be taken. Assess the ground condition/slope and any overhead obstructions or hazards and wind conditions.

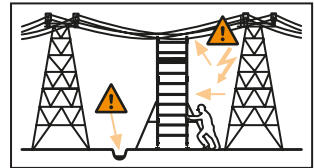

- Ensure there are no persons, tools, or materials on the tower.

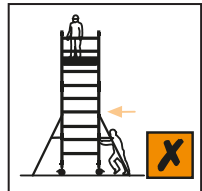

- Release the castor brakes.
- Release the stabiliser top clamp to allow the feet to be raised a maximum of 25mm. Re-tighten the clamps.

## 3 Using the Tower

### During

- The tower must be moved only by manual effort, pushing at the base of the tower.
- The tower should never be moved faster than normal walking speed.
- Constant attention must be given to the position of the castors, stabiliser feet and the top of the tower.
- If there is any resistance to movement, stop and investigate the reason before continuing.

### After

- As soon as the move is complete; lock the castor brakes, level the tower, lower the stabiliser feet, and perform the pre-use inspection.





For further information and support for the Clima or any other products, design advice and services, please contact:

Werner UK Sales & Distribution Ltd.  
Blackwater Trading Estate,  
The Causeway, Maldon,  
Essex, CM9 4LJ,  
United Kingdom

WernerCo Hungary Kft.  
6000 Kecskemét,  
Szt. Istvan Krt. 19.

☎ +44 (0)1621 745900

✉ uk.customer@wernerco.com

🌐 bossacesstowers.com

Werner UK Sales & Distribution Ltd.  
is a manufacturer member of:

